

Amelie _Wall



Amelie is a collection of portable, rechargeable battery-operated lamps, designed by Sara Moroni, that includes the following models: table, floor, wall and suspension lamps, and lamp with peg.

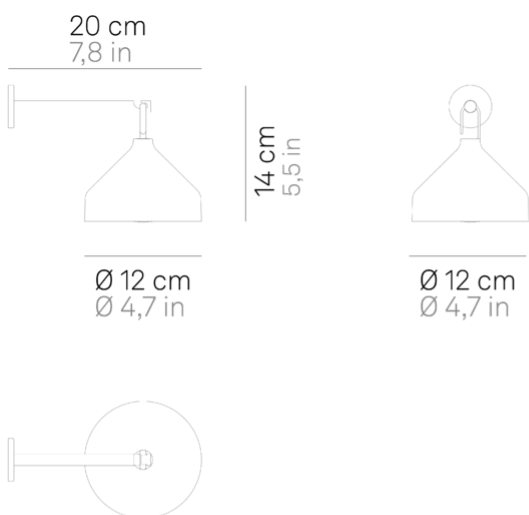

The wall lamp is supplied with a silicone hook and a cap, so that they can be transformed into a suspension lamp.

On the head, a touch sensor allows you to switch it on, adjust the luminous intensity and select the color temperature of the light to 2200 K, 2700 K or 3000 K. With the high IP rating, the lamps can also be used outdoors. The lamps come with a contact charging base; battery charger not included.



LED dimmable IP65

LD1092

	White	B3		Black	D3
	Terracotta	T3		Leaf green	V3



DESIGN IN ITALY BY ZAFFERANO SRL, MADE IN PRC

Zafferano SRL - Viale dell'Industria, 26 31055 Quinto di Treviso - Italy www.zafferanoitalia.com

Amelie _Wall

Lighting specifications

source	LED
type	SMD
total power	3.0 W
power LED	3.0 W
color temperature	2200 - 2700 - 3000 K
lumen lamp	95 - 116 - 130 lm
lumen LED	253 - 300 - 308 lm
beam angle	110°
CRI	> 80
class	G
dimmer	TOUCH DIMMER
motion sensor	NO

Electrical specifications

classe	3
supply voltage	5Vdc max.1A
battery	
battery life	10 h.
charging time	6 h.

ACCESSORIES

LD0340RA



6 cm • 13.5 cm • 4.5 cm • 3.0 W
• IP20 • 100-240V • 50/60 Hz

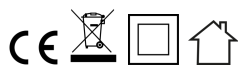

■ Black

LD0490UA

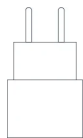

2.5 cm • 4 cm • 8 cm • IP20
• 100-240V • 50/60 Hz

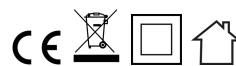

■ White

LD0870RP



29 cm • 47 cm • 4 cm • 3.0 W
• IP20 • 100-240V • 50/60 Hz

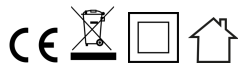

■ Black